

GLAM OPERATIVA

SCRIVANIE

G1

STRUTTURE METALLICHE : ALLUMINIO O BIANCO LUCE
FINITURE: ACERO - NOCE CANALETTO - BIANCO LUCE

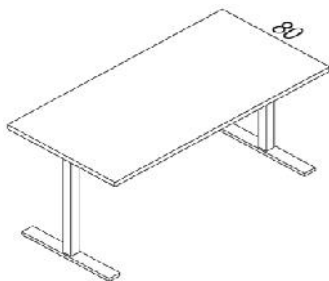

- 40.1293 - mm 800X800X740H - SGL 080
- 40.1294 - mm 1000X800X740H - SGL 100
- 40.1295 - mm 1200X800X740H - SGL 120
- 40.1296 - mm 1400X800X740H - SGL 140
- 40.1297 - mm 1600X800X740H - SGL 160
- 40.1298 - mm 1800X800X740H - SGL 180

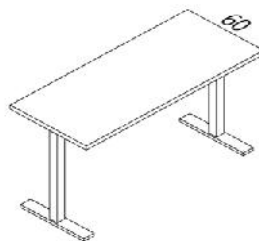

- 40.1299 - mm 1200X600X740 - PGL 120
- 40.1300 - mm 1400X600X740 - PGL 140
- 40.1301 - mm 1600X600X740 - PGL 160

G3

STRUTTURA
PIANO SPESSORE MM 30
FINITURE: ACERO - NOCE CANALETTO - BIANCO LUCE

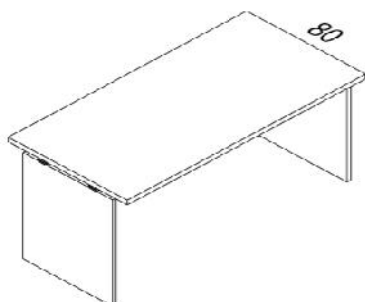

- 40.1311 - mm 800X800X740H - SLG 080
- 40.1312 - mm 1000X800X740H - SLG 100
- 40.1313 - mm 1200X800X740H - SLG 120
- 40.1314 - mm 1400X800X740H - SLG 140
- 40.1315 - mm 1600X800X740H - SLG 160
- 40.1316 - mm 1800X800X740H - SLG 180

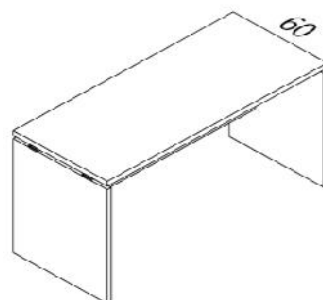

- 40.1317 - mm 1200X600X740 - PLG 120
- 40.1318 - mm 1400X600X740 - PLG 140
- 40.1319 - mm 1600X600X740 - PLG 160

SCHIENA IN LAMIERA PER SCRIVANIA
COLORE ALLUMINIO



- 40.1353 - mm 1100X340H - LMG 140 AL
- 40.1354 - mm 1300X340H - LMG 160 AL
- 40.1355 - mm 1500X340H - LMG 180 AL

SCHIENA IN LEGNO PER SCRIVANIA
FINITURE: ACERO - NOCE CANALETTO - BIANCO LUCE



- 40.1356 - mm 1100X300H - LLG 140 AL
- 40.1357 - mm 1300X300H - LLG 160 AL
- 40.1358 - mm 1500X300H - LLG 180 AL

GLAM OPERATIVA

ANGOLI E CASSETTIERE

FINITURE : **AC** = ACERO - **GL**=BIANCO LUCE - **NC**= NOCE CANALETTO

ANGOLO 90°

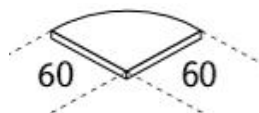

mm 600X600
40.1332 - APG 090

ANGOLO ASSIMETRICO DESTRO

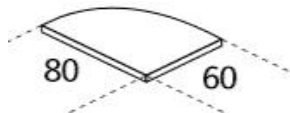

mm 800X600
40.1333 - ADG 090

ANGOLO ASSIMETRICO SINISTRO

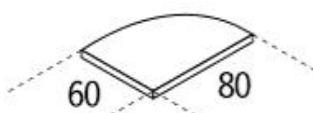

mm 800X600
40.1334 - ASG 090

ANGOLO 90°

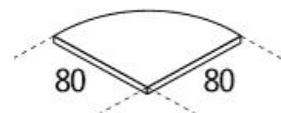

mm 800X800
40.1335 - ANG 090

ANGOLO 45°

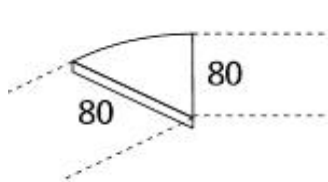

mm 800X800
40.1336 - ANG 045

TERMINALE TONDO PER SCRIVANIE

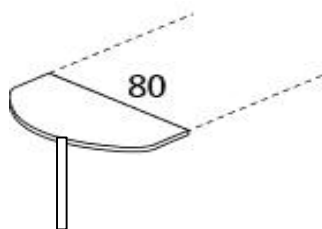

mm 800X400
40.1337 - TSG 040

TERMINALE DOPPIO PER SCRIVANIE

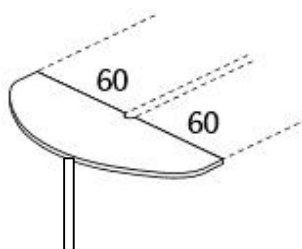

mm 1260X300
40.1338 - TDG 126 AL

TERMINALE DOPPIO PER SCRIVANIE

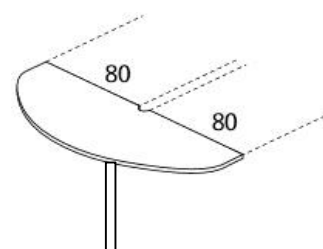

mm 1660X400
40.139 - TDG 166 AL

RACCORDO COMPLANARE

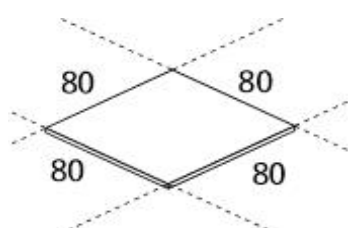

mm 800X800
40.1340 - ANG 080

PIANO COMPLANARE DA MM 800

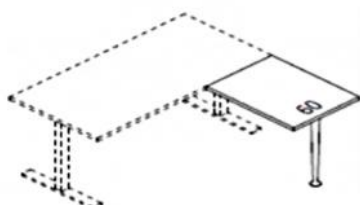

mm 800X600X740H
40.1341 - ALG 080

PIANO COMPLANARE DA MM 600

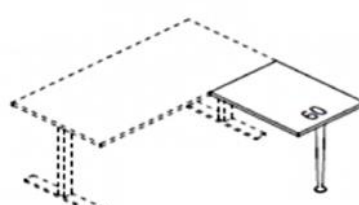

mm 1200X600X740H
40.1342 - ALG 120

GAMBA FISSA PER ANGOLI



mm 740H
40.1343 - GMG 16

CASSETTIERA C/RUOTE 3 CASSETTI



mm 420X530X550H

40.1344 - CAG 042 AC
40.1345 - CAG 042 GL
40.1346 - CAG 042 NC

CASSETTIERA C/ RUOTE 1 CASSETTO + CASSETTO CLASSIFICATORE



mm 420X530X550H

40.1348 - CAG 050 AC
40.1349 - CAG 050 GL

CASSETTIERA C/ RUOTE 3 CASSETTI



mm 42,50X530X580H

40.1350 - CAM 420 ALA
40.1351 - CMX 420 BI

metallo

CASSETTIERA C/ RUOTE 1 CASSETTO+ CASSETTO CLASSIFICATORE



mm 42,50X530X580H

40.1352
CAM 520 ALA

metallo

GLAM OPERATIVA

LIBRERIE

STRUTTURE : **AL**= ALLUMINIO - **GL** = BIANCO LUCE - ANTE LEGNO: **AC** = ACERO
GL= BIANCO LUCE - **NC**= NOCE CANALETTO - ANTE VETRO **CS** = ACIDATO

LIBRERIA BASSE
A GIORNO H. 70

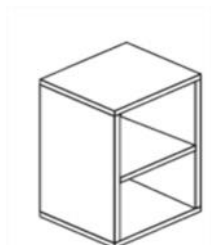

mm 450X400X700H

40.1359 - LBG 200 AL
40.1361 - LBG 200 GL

ANTA BASSA SINGOLA
LIBRERIA H.70

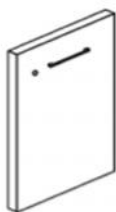

mm 450X670H

40.1362 - ABGS AC 67
40.1363 - ABGS GL 67
40.1364 - ABGS NC 67

LIBRERIA BASSE
A GIORNO H. 83

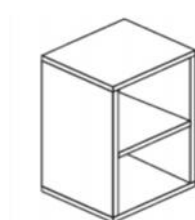

mm 450X400X830H

40.1366 - LBG 208 AL
40.1368 - LBG 208 GL

ANTA BASSA SINGOLA
LIBRERIA H.83

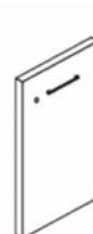

mm 450X770H

40.1369 - ABGS AC 77
40.1370 - ABGS GL 77
40.1371 - ABGS NC 77

LIBRERIA BASSE
A GIORNO H. 70

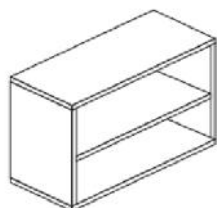

mm 900X400X700H

40.1373 - LBG 300 AL
40.1375 - LBG 300 GL

COPPIA ANTE PER
LIBRERIA H.70

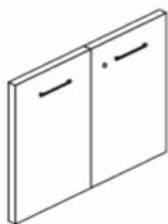

mm 900X670H

40.1376 - ABG AC 67
40.1377 - ABG GL 67
40.1378 - ABG NC 67

LIBRERIA BASSE
A GIORNO H. 83

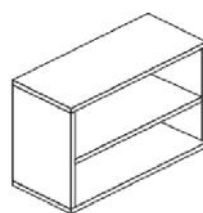

mm 900X400X830H

40.1380 - LBG 308 AL
40.1382 - LBG 308 GL

COPPIA ANTE PER
LIBRERIA H.83

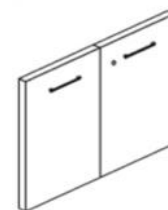

mm 900X770H

40.1383 - ABG AC 77
40.1383 - ABG GL 77
40.1385 - ABG NC 77

LIBRERIA MEDIA
A GIORNO

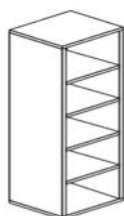

mm 450X400X1340H

40.1387 - LBG 220 AL
40.1389 - LBG 220 GL

ANTA MEDIA
SINGOLA



mm 450X1310H

40.1390 - AMGS AC 13DX
40.1391 - AMGS GL 13DX
40.1392 - AMGS NC 13DX

ANTA MEDIE SINGOLA
PER SOVRAPPOSIZIONE



mm 450X1310H

40.1394 - AMGS AC 13
40.1395 - AMGS GL 13
40.1396 - AMGS NC 13

VETRO MEDIO DESTRO
TELAIO ALLUMINIO



mm 450X1310H

40.1398
VSS780TAS

GLAM OPERATIVA

LIBRERIE

STRUTTURE : **AL**= ALLUMINIO - **GL** = BIANCO LUCE - ANTE LEGNO: **AC** = ACERO
GL= BIANCO LUCE - **NC**= NOCE CANALETTO - ANTE VETRO **CS** = ACIDATO

LIBRERIA MEDIA
A GIORNO

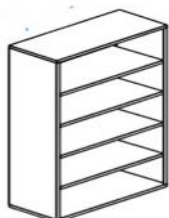

mm 900X400X1340H

40.1401 - LBG 340 AL
40.1403 - LBG 340 GL

COPPIA ANTE
MEDIE

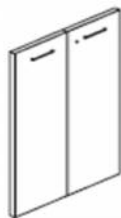

mm 900X1310H

40.1404 - AMG AC 13DX
40.1405 - AMG GL 13DX
40.1406 - AMG NC 13DX

COPPIA ANTE MEDIE
PER SOVRAPPOSIZIONE



mm 900X1310H

40.1408 - AMG AC 13
40.1409 - AMG GL 13
40.1410 - AMG NC 13

COPPIA VETRI MEDI
TELAIO ALLUMINIO



mm 900X1310H

40.1412
CCS 780TAS

LIBRERIA ALTA
A GIORNO

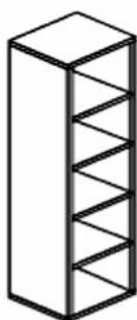

mm 450x400x2020H

40.1415 - LBG 280 AL
40.1417 - LBG 200 GL

ANTA ALTA SINGOLA



mm 450X2000H

40.1418 - AAGS AC19
40.1419 - AAGS GL 19
40.1420 - AAGS NC 19

ANTA ALTA
VETRO SINGOLA

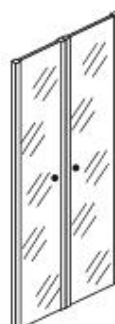

mm 450X2000H

VSS 750 TAS
40.1422

LIBRERIA ALTA
A GIORNO

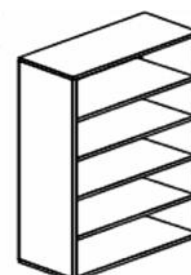

mm 900X400X2020H

40.1425 - LBG 420 AL
40.1426 - LBG 420 GL

COPPIA ANTE ALTE



mm. 900X2000H

40.1428 - AAG AC 19
40.1429 - AAG GL 19
40.1430 - AAG NC 19

COPPIA ANTE ALTE
VETRO

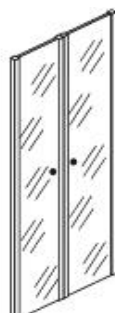

mm 900x2000H

40.1432 - CCS 750 TAS

CLASSIFICATORE
ORIZZONTALE H.70



mm 900X420X700H

40.1435 - CLG 400 AC
40.1436 - CLG 400 GL
40.1437 - CLG 400 NC

CLASSIFICATORE
ORIZZONTALE H. 83

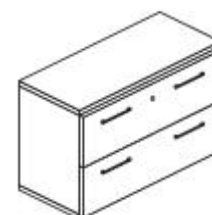

mm 900X420X830H

40.1439 - CLG 480 AC
40.1440 - CLG 480 GL
40.1441 - CLG 480 NC

GLAM OPERATIVA

ACCESSORI PER LIBRERIE

FIANCHI : FINITURA : NOCE CANALETTO

COPPIA FIANCHI FINALI
BASSI



mm 420X690H

40.1443 - FBG 072 NC

COPPIA FIANCHI FINALI
BASSI



mm 420X820H

40.1445 - FBG 082 NC

COPPIA FIANCHI FINALI
MEDI

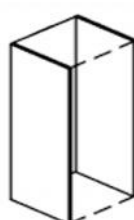

mm 420X1340H

40.1447 - FMG 132 NC

COPPIA FIANCHI FINALI
ALTI

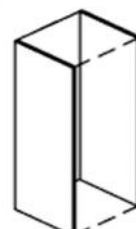

mm 420X690H

40.1449 - FAG 192 NC

TOP DI FINITURA

AC= ACERO - GL= BIANCO LUCE - NC= NOCE CANALETTO

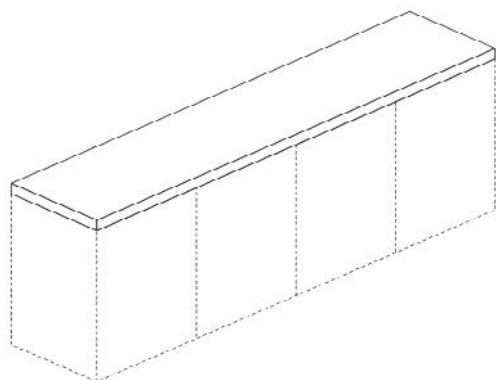

mm 1350X420

40.1459 - TPG 135 AC
40.1460 - TPG 135 GL
40.1461 - TPG 135 NC

mm 1800X420

40.1463 - TPG 180 AC
40.1464 - TPG 180 GL
40.1465 - TPG 180 NC

mm 450x420

40.1451 - TPG 045 AC
40.1452 - TPG 045 GL
40.1453 - TPG 045 NC

mm 900x420

40.1455 - TPG 090 AC
40.1456 - TPG 090 GL
40.1457 - TPG 090 NC

mm 2250X420

40.1467 - TPG 225 AC
40.1468 - TPG 225 GL
40.1469 - TPG 225 NC

mm 2700X420

40.1471 - TPG 270 AC
40.1472 - TPG 270 GL
40.1473 - TPG 270 NC